

Shokwaves in the Ionosphere



How to build a worldwide

Earthquake Detector ;

with a standard

Shortwave Receiver

E-Layer

Field Lines

High density area of the ionosphere

Earthquake

Dead zone

40 m radio waves

40 m radio coverage

40 m radio transmitter



by

Alex Schwarz

(VE7DXW)

by VE7DXW
© 2020

How do Earthquakes create Electromagnetic Fields

- Piezoelectric effect of rocks sliding and vibrating on top of each other.
- Micro Fractures of rocks releasing vast amounts of free electrons.
- Electrons move up towards the surface or seafloor and circulate around the quake area.
- Electromagnetic fields start to emerge out of the earth crust and move upward towards the ionosphere.
- Since the ionosphere contains charged particles the magnetic field interacts with the ions and creates a hole or a dome of charged particles, affecting radio waves passing through.
- For more information see Scientific American Oct. 2018: “Earthquakes in the Sky” (see ref. at the end)

A hole in the Ionosphere?

- The magnetic field lines reach into the ionosphere and disturb or bend the layers, breaking existing radio paths. The signals that the Seismograph receives drop out!

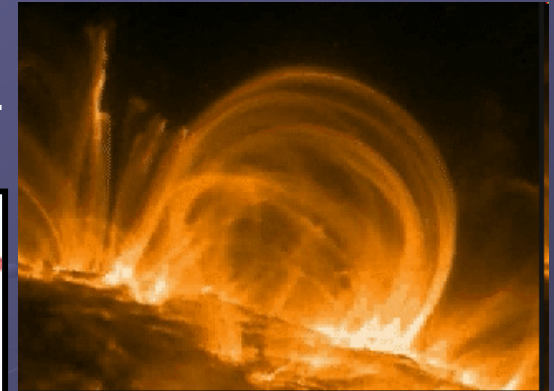
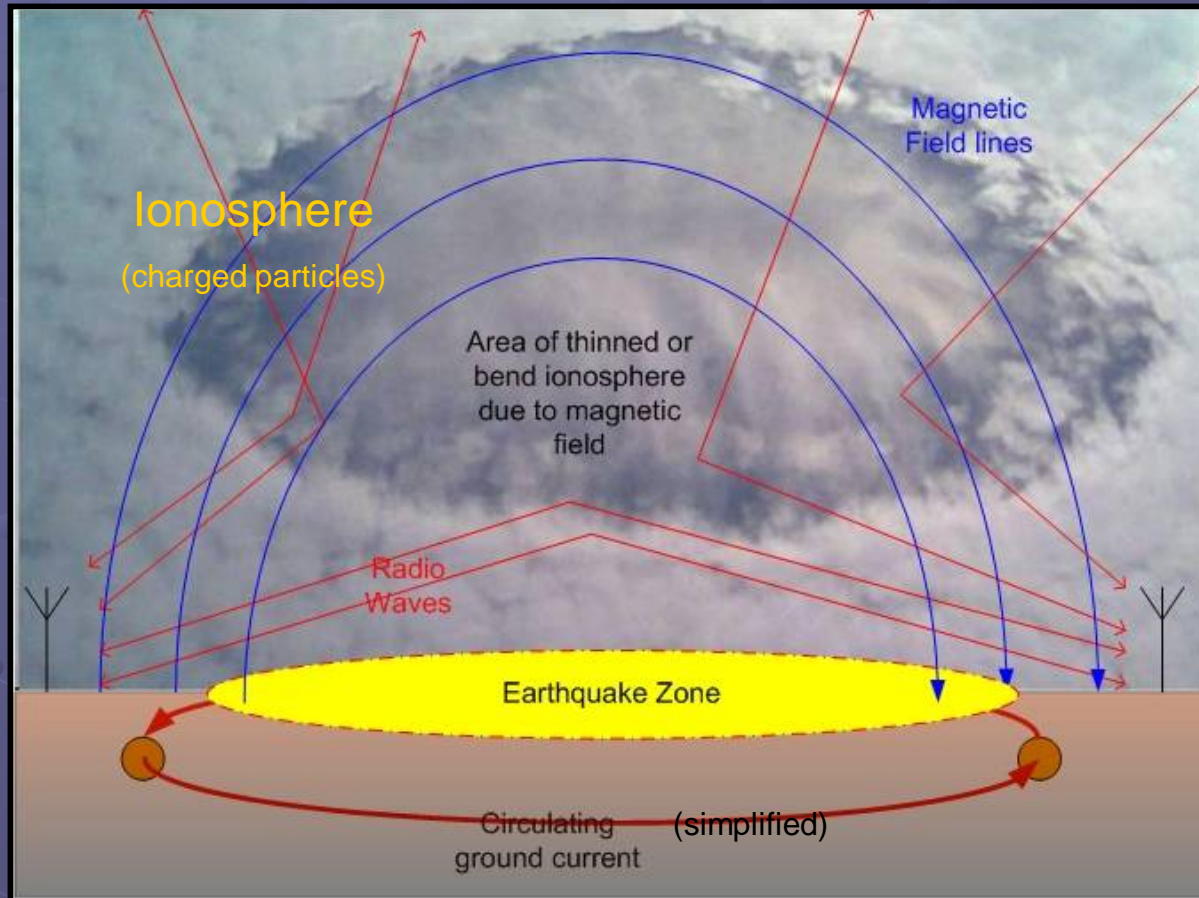

The equivalent of a magnetic field shooting out of the surface of the sun. Because of the hot plasma, the field lines are visible. This process on the sun is much more energetic than an earthquake here on earth, but the physics are the same.

Boyarchuck's and Pulinet's RF quake experiment (2002)

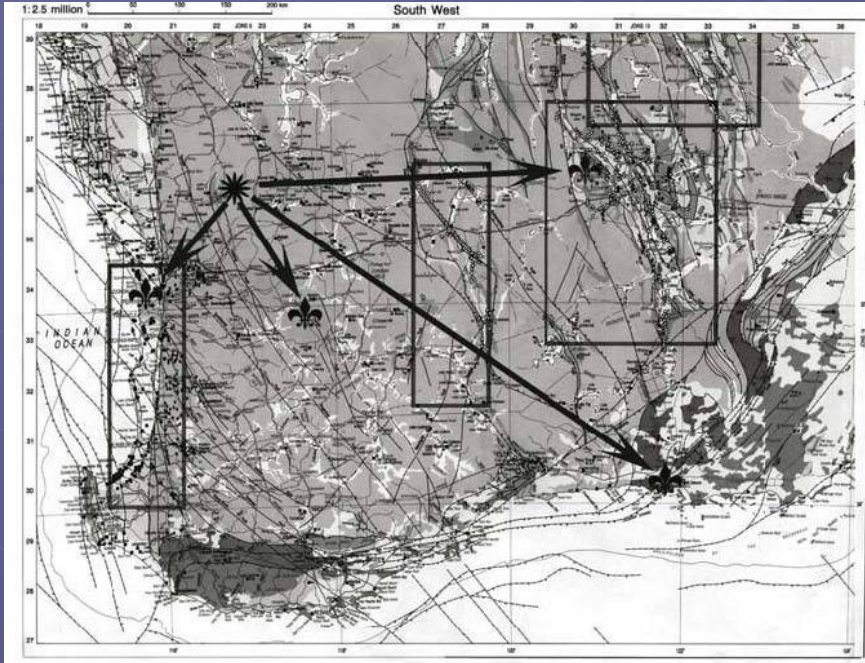

In their 2005 book “Ionospheric Precursors of Earthquakes”, Sergey Pulinet and Kirill Boyarchuck describe an experiment on page 251, chapter 7.2.1; that took place in 2002 in the Australian Outback that was using shortwave frequencies to detect earthquakes.

The measurement was carried out on the following frequencies:

129 -132 kHz, 2.3 MHz, 4.2 MHz, 148.060 MHz

Issues with the setup: the frequencies used are not used around the world, therefore the skip behavioral change, caused by the field-lines of the quakes cannot be detected and only direct RF noise was measured.

Principle of Operation

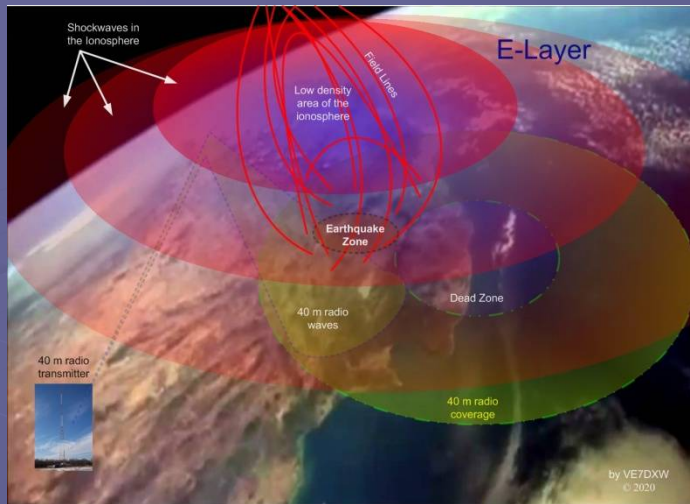

The magnetic field of a developing earthquake exits the ground and starts to attract (bend) the ionosphere. This is a slow process, but can be jittery at times. If the quake is strong – above M5.9 on average – the ionosphere is overloaded and transition waves occur. This is very common when the ionosphere is thin as in low solar flux conditions. This behavior is always linked to quakes and not to solar activity.



The measurements of August 25, 2020, show exactly that behavior, after 12:00 UTC. There is smaller quake at 12:15 UTC and it attenuates the 40 m (green) first and then as the M6.1 starts to build, there is 40 m propagation after 12:45 UTC, peaking at 13:00 UTC and then fading with the event of another quake. The transitions of the 40 m band are mostly marked (within +/- 10 min) by a quake. Double events where a M6.1 is followed by a M5.1, regardless of location, have a stronger impact on propagation, here opening the 20 m band from 18:30 UTC for 3 h. The transition between propagation and total signal loss is quick as can be seen with the dropout of the 20 m band 19:15 UTC lasting for 45 min. As the M5.1 strikes at 20:00 UTC the 20 m band comes back immediately. 20 m is good for another 2 h and then fades again with another significant quake.

The different types of measurement (Passive and semi passive measurement)

The RF-Seismograph performs a passive and a semi-passive measurement and the same time.

- The passive measurement only records the noise level.
- The semi-passive measurement is mainly on the digital section of each band (such as JT-65 and FT-8).

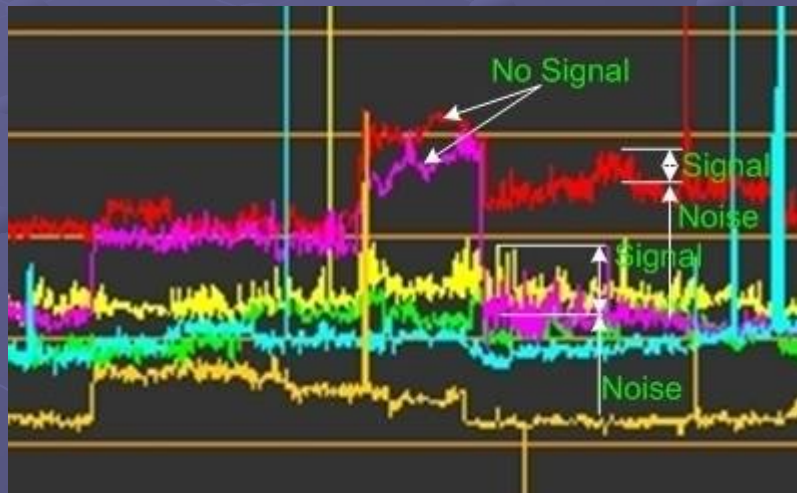

- no changes to the noise level; the result is a flat line
- no signal present; the MDSR displays a thin line which moves up and down recording the noise level
- with a signal present; the graph goes wide and moves up and down with the noise level.

Why does the ionosound not show this behavior? It probably could, but the standard measurement interval is 15 min and, therefore, will not record the faster changes of the quakes.

Creating a world-wide propagation network to detect earthquakes

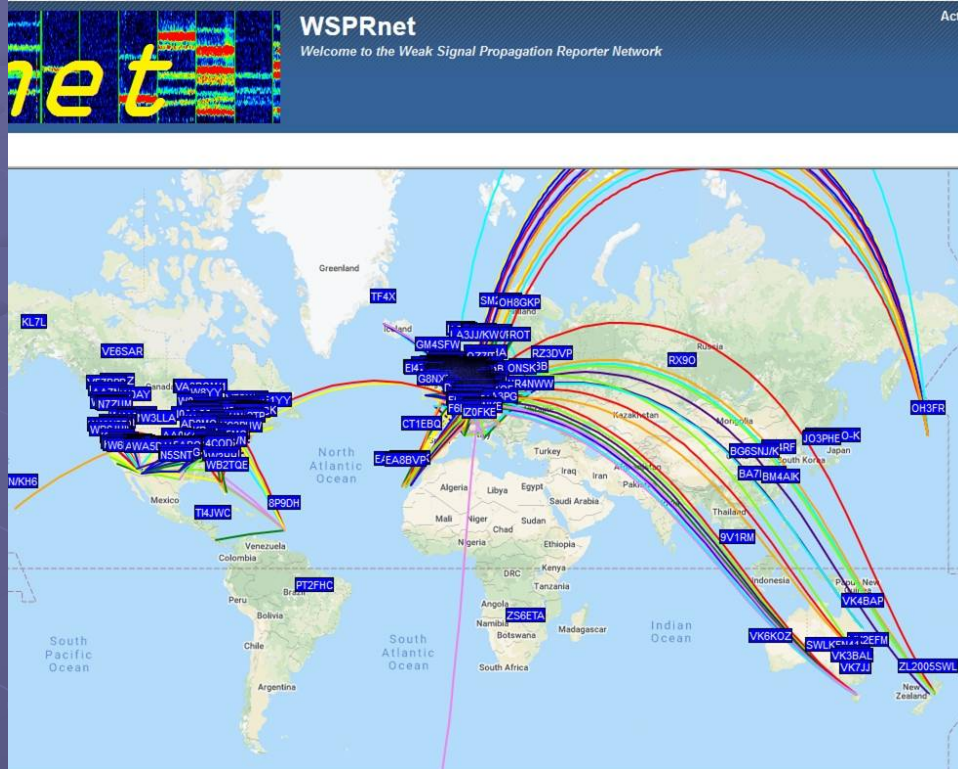

Thanks to the ingenuity of HAMs worldwide, we have digital modes that utilize the available HF bands on a specific frequency on each band.

WSPR and JT modes are used on almost all available HAM radio bands continuously, creating an oblique ionosound system with unlimited transmitting locations. Whenever there is an available path the RF-Seismograph will record it on six bands in real-time.

Earthquake size and the impact on propagation

Earthquakes are very powerful events. A M4.0 quake is equivalent to 1000 tons of TNT, a small nuclear bomb. 1,000 Tons Of TNT are equal to 1162 MWh. Considered that these quakes only last for a few seconds, the actual power output can reach more than 1 GW!

Band	Behavior of bands to Quakes (SFI = 70)				
B [m] – f [MHz]	M2.0	M3.0	M4.0	M5.0	M6.0
80 - 3.076	propag.	propag.	propag.	atten.	atten.
40 m - 7.076	clusters	propag.	propag.	propag.	atten.
30 m - 10.138	none	clusters	clusters	propag	atten.
20 m – 14.076	none	none	clusters	propag	sporadic
15 m – 21.076	none	none	none	atten.	atten.
10 m - 28.076	spike	spike	spike	spike	spike

- The behavior of the bands also depends on solar wind. As solar wind increases, the propagation shifts upward and small quakes have a bigger impact on propagation and the skip frequency goes up.

Impact of Solar Wind

August 9, 2020, was a very quiet day in regards to earthquakes. The strongest one was a M5.3 from Prince Edward Island (South Pacific). What was different was the speed and density of the solar wind that made shortwave propagation difficult. The RF-Seismograph picks up solar wind in the frequencies 20 MHz and above. The noise recording of this day clearly shows that the solar wind was already active at 00:00 UTC and the first bout lasted until 05:00 UTC. What is unusual is that the solar wind from 02:00 UTC to 05:15 UTC is also visible on the lower bands, especially on 80 m and 40 m. The reason why it was visible was the fact that the cluster of quakes shredded the ionosphere and it allowed solar wind to penetrate closer to the ground.

Another bout of solar wind comes in after 06:00 UTC, but is weaker and is only seen on the 15 m band lasting to 09:30 UTC. 80 m and 40 m propagation is available but very noisy. With the approach of two M5+ quakes at midday the 40 m band attenuates, but 80 m is enhanced.

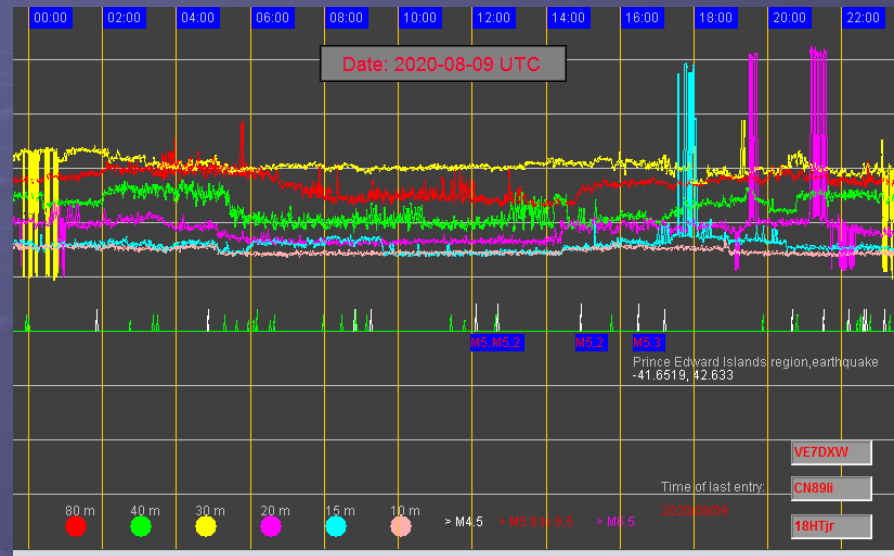

The third wave of solar wind started after 14:30 UTC, indicated by the rise in noise level on all bands. There were two more M5+ quakes within 60 min of each other and the effect of the quakes was enhanced because of the wind and the fact that they released in short order. With the release of the last quake the 15 m starts to open up and was available from 17:15 UTC for 2 h. The solar wind quits in two stages, first the drop of noise on 10 m at 19:00 UTC and then the drop of noise at 20:30 UTC. As the solar wind eases off, the MUF goes down to 20 m.

Multiple Quakes cause Long Pass to Europe

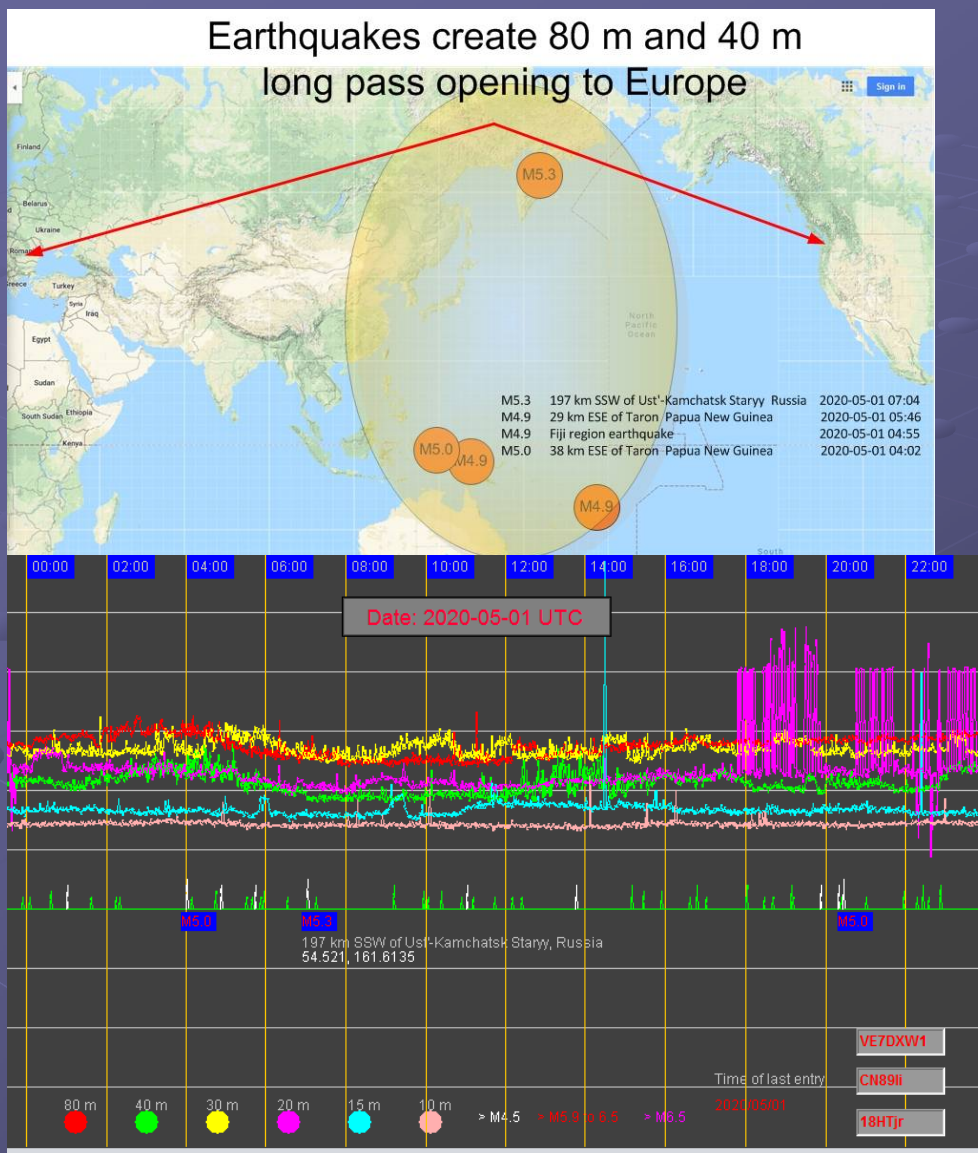

May 1st is always a busy time for contests, and this year was no different. While the SFI index in May was below 70, the contest participants from the West Coast were treated to a Long Path opening on 80 m and 40 m to Europe created by four quakes. The quakes involved were located in the south and north Pacific and released within 2 h of each other. This created workable propagation starting at 02:00 UTC lasting for almost 4 h.

Why do we need big antennas to monitor Propagation and Noise



When monitoring background noise, it is imperative to use a big, preferably omnidirectional antenna like the 18HTjr from Hy-Gain. This antenna is capable of covering all the major amateur bands, including 80m. Each band that we record must have a defined resonant element on this antenna. Big antennas are not only more efficient, they are also a lot less interference-prone, due to local near field changes. This means that some maintenance can be done without having to turn off the RF-Seismograph. Especially when the monitoring is over long periods of time, maintaining the antenna while it is recording with a minimum of interference is a big plus.

How to store and search the data we have collected

Timestamp	3576000	7076000	10138000	14076000	21076000	28076000
2/12/2019 23:41	-36.65	-39.51	-41.9	-50.22	-53.72	-55.76
2/12/2019 23:42	-38.24	-40.31	-41.48	-50.43	-54.17	-55.13
2/12/2019 23:42	-38.1	-40.62	-42.06	-51.12	-54.5	-55.94
2/12/2019 23:43	-37.99	-39.44	-41.81	-49.87	-54.21	-55.78
2/12/2019 23:44	-36.86	-39.75	-41.77	-49.24	-55.24	-55.89
2/12/2019 23:45	-37.1	-39.62	-41.41	-50.26	-54.88	-55.41
2/12/2019 23:46	-37.42	-39.79	-41.27	-51.25	-54.78	-55.81
2/12/2019 23:47	-36.53	-38.22				
2/12/2019 23:48	-35.92	-38.37				
2/12/2019 23:49	-37.25	-40.41				
2/12/2019 23:50	-37.72	-39.75				
2/12/2019 23:51	-36.73	-39.38				
2/12/2019 23:51	-36.05	-39.7				
2/12/2019 23:52	-36.65	-39.65				
2/12/2019 23:53	-36.87	-39.88				
2/12/2019 23:54	-36.38	-40.15				

Collecting information on propagation creates huge files. The RF-Seismograph measures 6 bands every 52s. It creates a log file every day at midnight and has, since the time it is running, collected over 150MB of information.

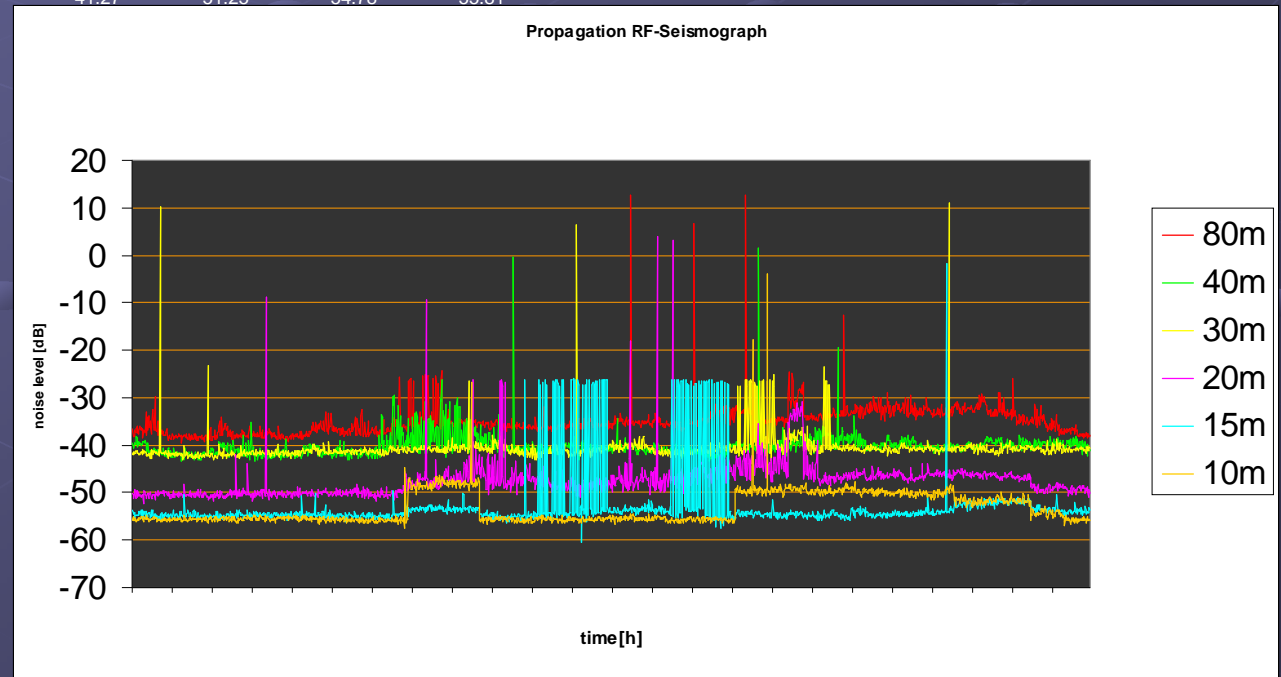

How sensitive is the RF-Seismograph?

In the first phase of our research, we were looking at small events, preferably something manmade. North Korea came to mind, which has been conducting underground atomic tests. The bomb that exploded on Sept. 9, 2016, at Punggye-ri site was estimated to be 15 to 25kt (just a bit larger than Hiroshima). If it exploded on the surface it would have the power to create a M6+ size earthquake!

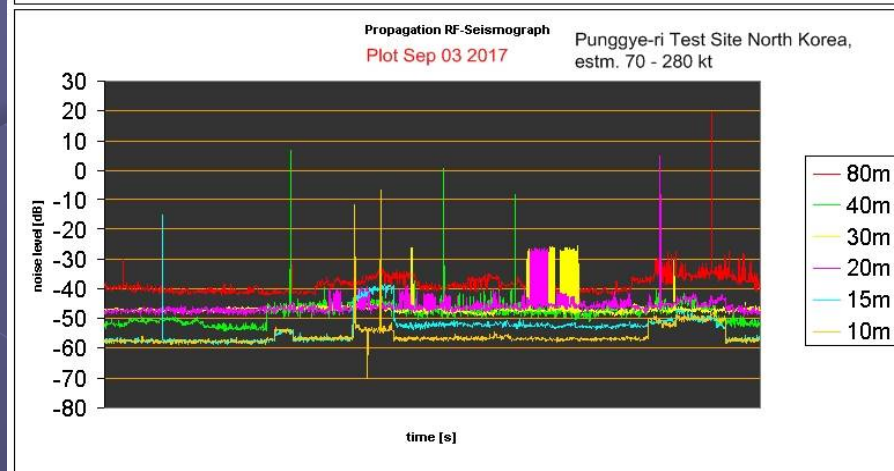
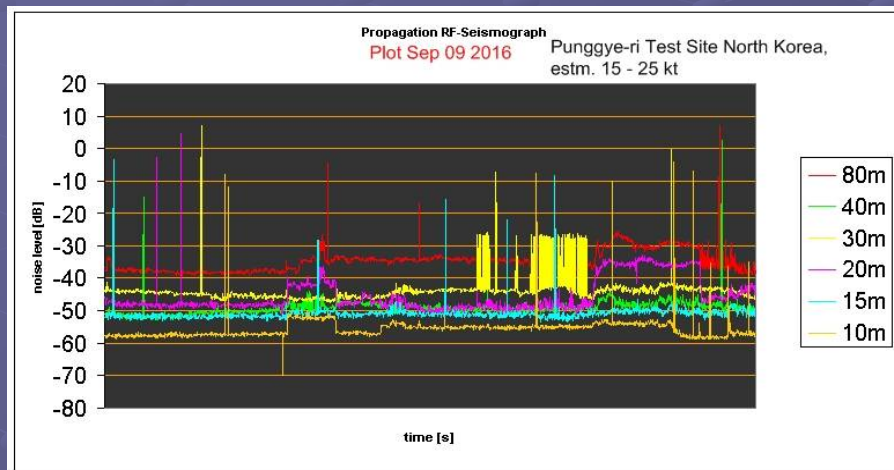

Since the test was underground, the effects on the surface, the ionosphere and the EMP were much attenuated. Nevertheless, the RF-Seismograph recorded a blip and a delayed reaction and change of propagation.

The second event was much larger and had a yield of 70 to 280kt, but the time of the explosion does not match our data (listed on Wikipedia).

So the jury is still out...but why the times are different is anyone's guess!

The long term effect of Solar Flux

On Aug. 2016, the Solar Flux was at 100. The average noise level at the MDSR Space Weather Station -40 dB on 80 m and -58 dB on 10 m.

On Nov. 25, 2018, the Solar Flux was at 70 (the start of solar min). And the average noise level of the station has actually increased!

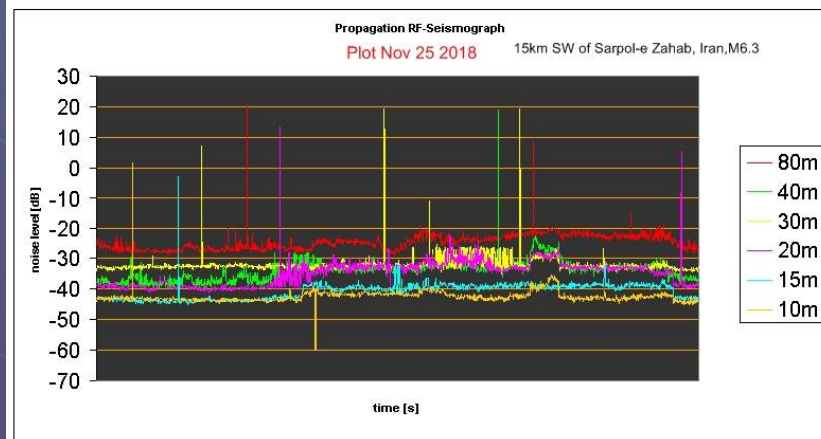
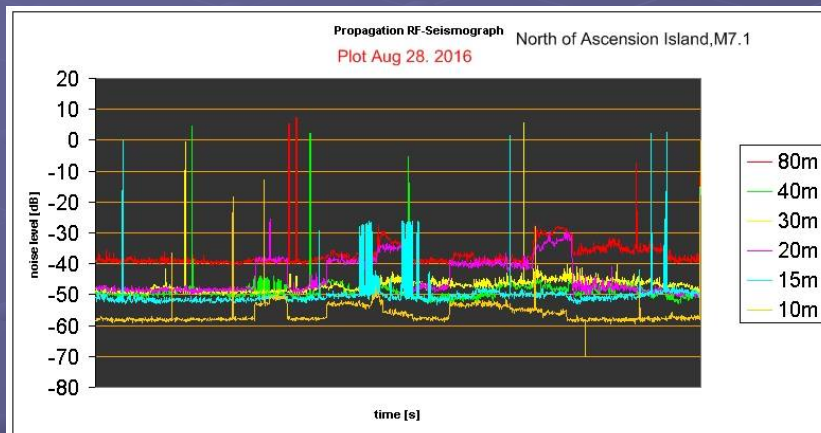

SFi at 100 will not help to open 15 (blue) and 10 m (salmon) so there is little activity on these bands. Unfortunately, the RF-Seismograph was not available during last solar max.

Conclusion: High solar flux makes the ionosphere more conductive so it radiates the local noise to other locations and hence the noise level drops.

Note: Both measurements were taken on days that were quiet as far as solar activity and solar wind.

The 4 Year Propagation vs. Earthquake Study

- 171 total Earthquakes were studied: All M6+ events from the beginning of our recording (Aug. 2016) to today. Events were provided by USGS and the quality of the data is high.
 - Only 15 quakes did not have RF-noise associated with them
 - 1 day was not recoverable due to data loss; out of 961
 - In 26 cases, the time of the disturbance did not match the time stated in the USGS report
 - In 122 quakes (72%), we were able to see a noise increase of the 80 m either before, after, and before and after the quake released. The before and after is the most common one. More analysis is needed.
 - Introduction and Study of Earthquakes (see ref. at the end)
<https://www.qsl.net/rf-seismograph/downloads/IntroductionRF-SeismographandEarthqakes.pdf>
- The study is still continuing and we need your help to set up more monitoring stations.

How is “RF Seismograph” connected to the Transceiver

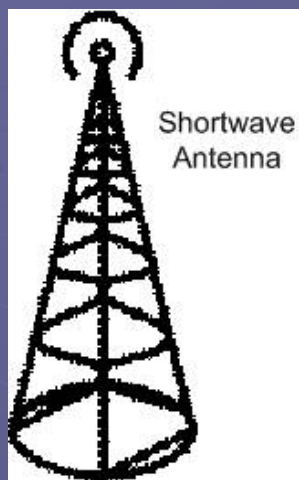

The station setup for the RF-Seismograph is exactly the same as for the MDSR. The 455kHz IF is extracted from the transceiver and then fed to the LIF converter. The LIF converts the IF to 12kHz. The Output of the LIF is connected to LINE in of the Soundcard. (24ADC for best performance)

The MDSR software needs to be installed.

RF-Seismograph is part of the MDSR software package. Download at:

<https://www.qsl.net/rf-seismograph/index.html>

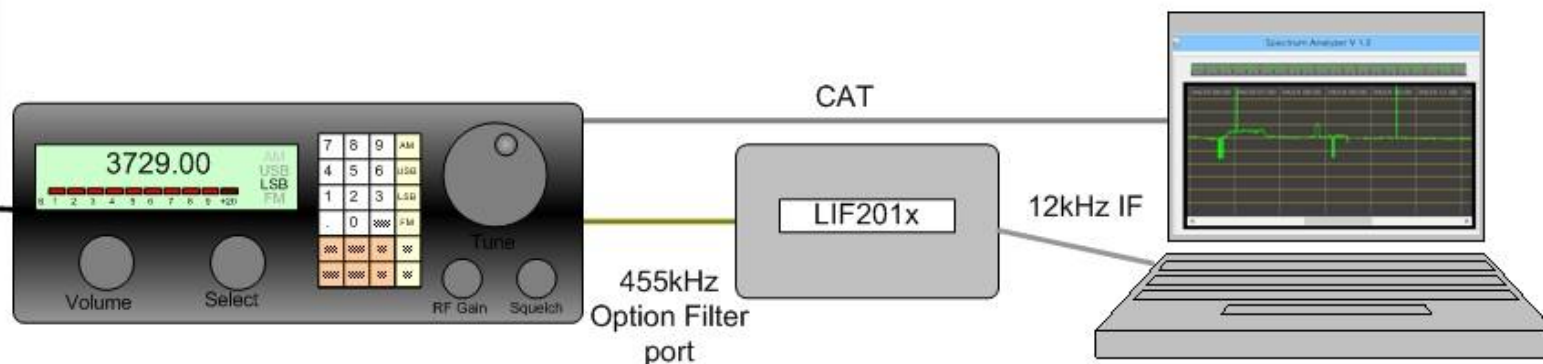

Hardware Implementation

The hardware design of the Raspberry Pi setup to run the RF-Seismograph has to include a sound-card with stereo line level output and input. The higher the quality of the sound-card input, the better the results for the received and demodulated signal. The Raspberry Pi unit requires 5V and draws up to 2A of power. This is different from all the amateur equipment that usually requires 13.8V.

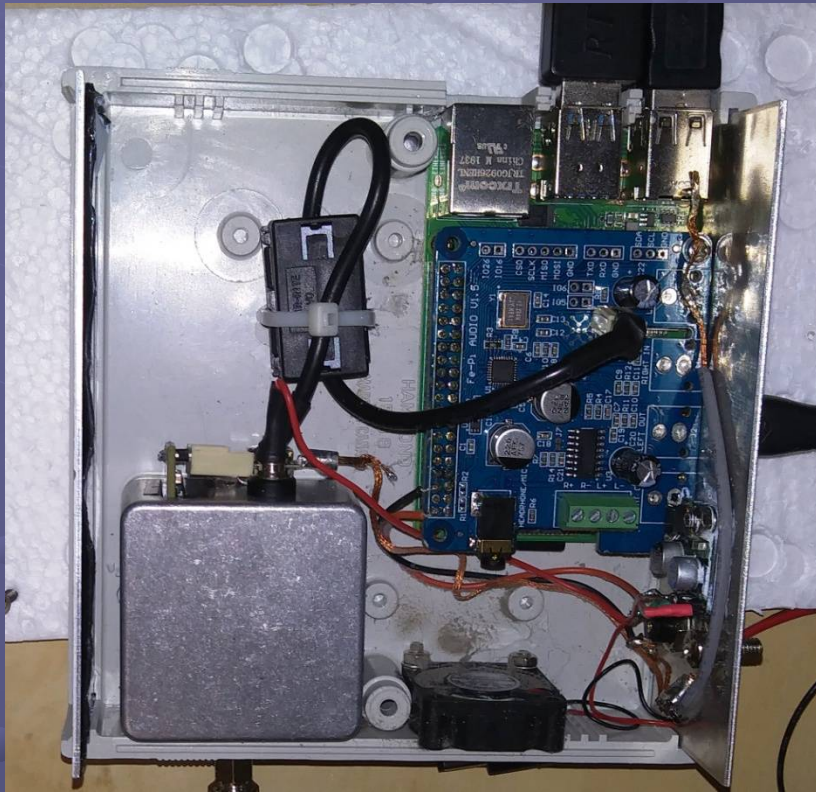

To simplify the setup of the unit, a Buck power regulator is implemented to reduce the 13.8V to 5V for the Pi. Since this is done internally, the Pi power connector remains empty. The connection between the LIF-2016 and the left audio line input is wired with high quality shielded audio cable. To reduce inductive RF currents on the shield, a clamp-on ferrite bead is placed over the cable. Grounding is required to reduce the induction of noise generated by the microprocessors and other digital circuits. For best grounding results, follow the schematics for grounding points.

How to setup the software is described in the [MDSR.io](https://www.mdsr.io) group Wiki.

RF-Seismograph setup for Portable use

The Linux version of the RF-Seismograph can also be set up for touch screen and portable operation. The Raspberry Pi and the sound card are mounted on the back of the screen. The radio is controlled via CAT interface. The LIF-2016 is required to connect the IF to the sound card.



5V 2A power is supplied via a 12V car power adaptor. The LIF interface (cast metal box) requires 12V/10mA power.

As always, receiver has to be moded for IF output, which the LIF converts to audio level.

To check out what transceivers can be adapted to use with the LIF interface check out our website at;

<https://www.qsl.net/rf-seismograph/index.html>

or our Groups.io/MDSR group at:

<https://groups.io/g/MDSRadio>

LIF 2016

- Fits into the option filter slot of many Yaesu and other radios
 - PCB size: 56 x 22mm (2.2 x 0.850") same pin out as option filter
- Only requires +12V to be wired from inside the radio
- 12 - 15kHz output ready for the Sound Card on TB3
 - RX only

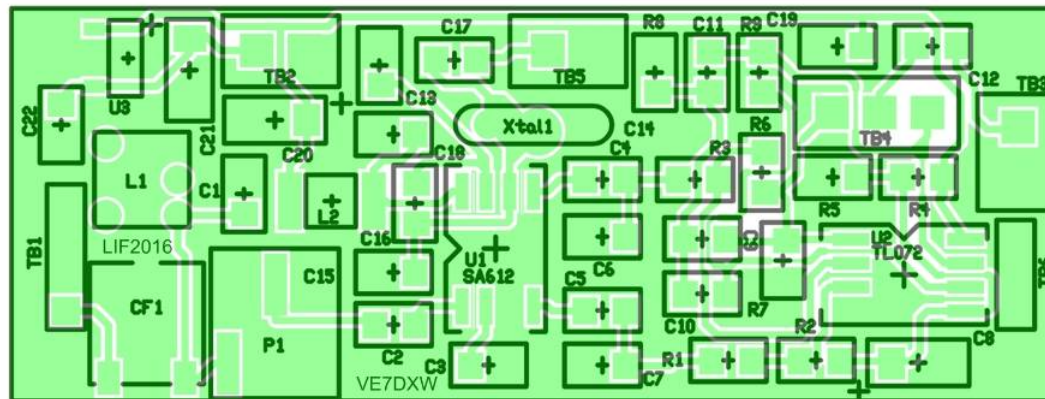

LIF2016F.TSS 04/06/16 10:42 am

References

Scientific American Oct. 2018: "Earthquakes in the Sky"

http://www.ep.sci.hokudai.ac.jp/~heki/pdf/Scientific_American_Vance2018.pdf

Ionospheric Precursors of Earthquakes, Sergey Pulnits and Kirill Boyarchuk

https://www.qsl.net/rf-seismograph/Literatur/2005_Book_IonosphericPrecursorsOfEarthqu.pdf

Earthquakes Canada:

<http://www.earthquakescanada.ca>

U.S. Geological Survey

<https://www.usgs.gov/>

Access to Study for 2017, 2018 (2019 is part of 2018)

https://www.qsl.net/rf-seismograph/downloads/Matches-RF-Seismograph_and_Seismic_data_for_2017.pdf

https://www.qsl.net/rf-seismograph/downloads/MDSR/Earthquakes_visible_with_RF-Seismograph_2018.pdf

Download and Install RF-Seismograph for Linux and Raspberry Pi

<https://groups.io/g/MDSRadio/wiki/home>

Download MDSR software for PC from:

<https://www.qsl.net/rf-seismograph/>

Questions?

Contact information:

Alex Schwarz: alexschwarz@telus.net

Website: <http://users.skynet.be/myspace/mdsr/>

IO Groups user group: <https://groups.io/g/MDSRadio>

Thank you for your interest and participation in this presentation

Kits are available from VE7DXW and our website (listed above).

© 2020